



LC 231

Emptying application



Further product documentation
net.grundfos.com/qr/i/99381576



Further product documentation
net.grundfos.com/qr/i/99480674

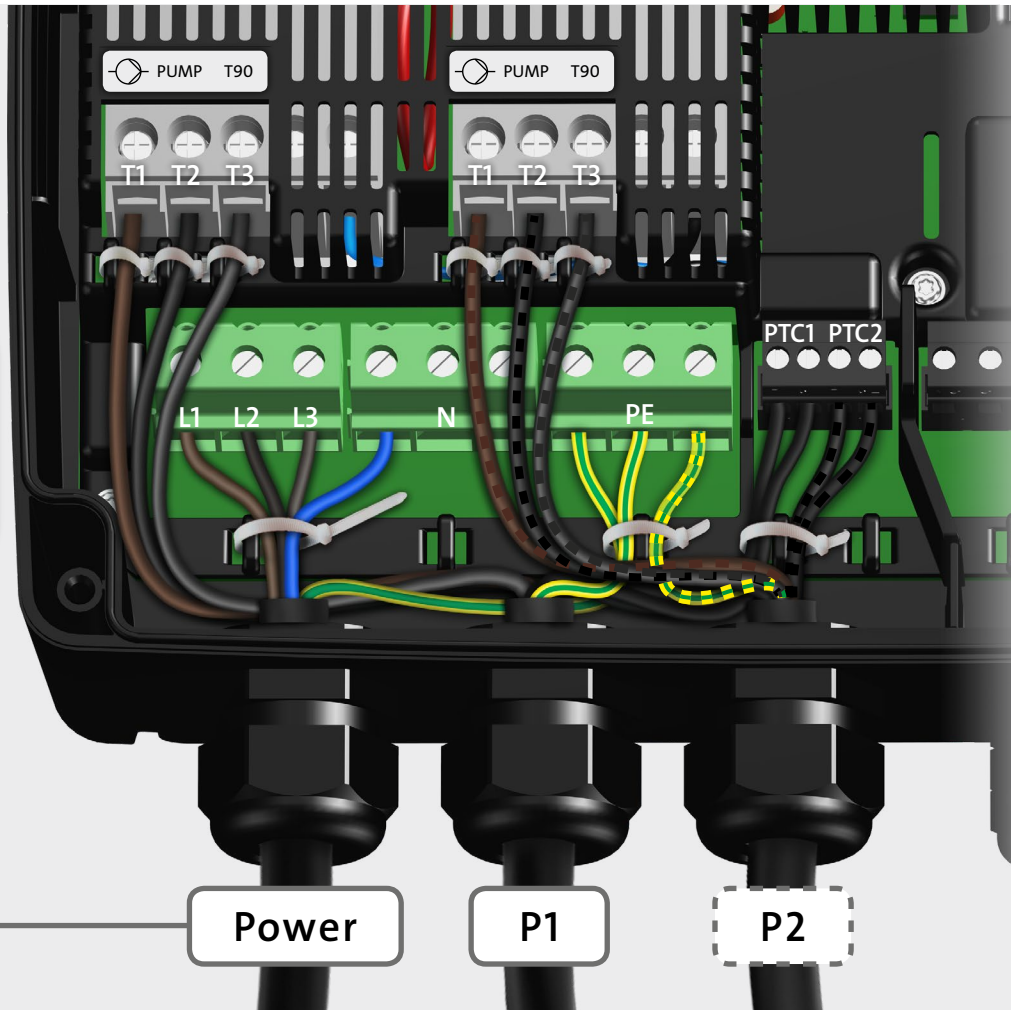
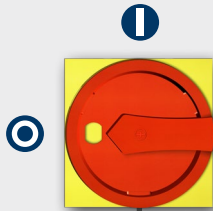
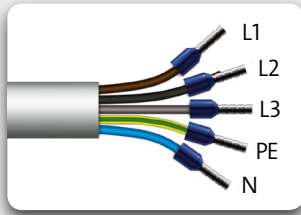

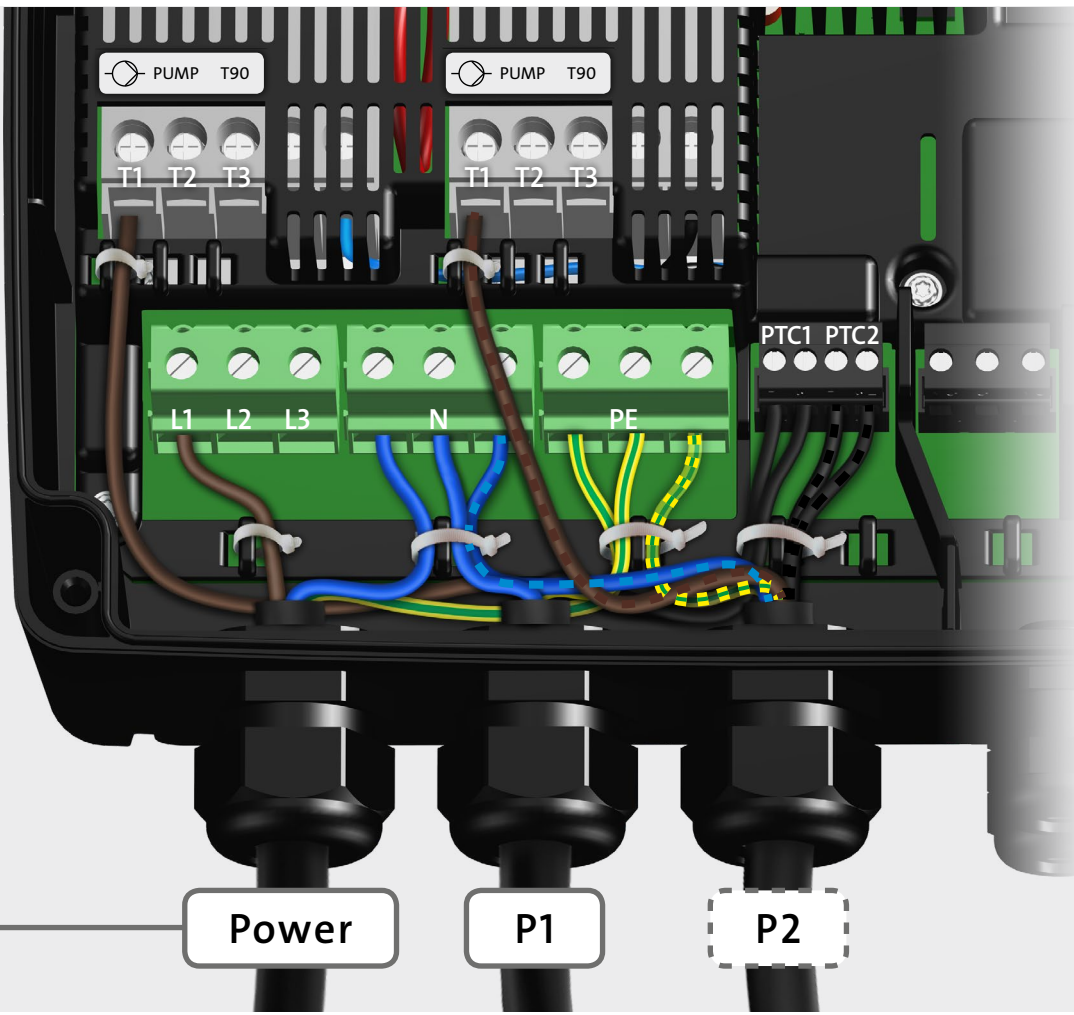
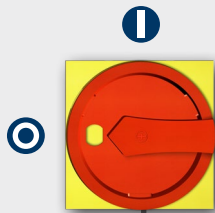
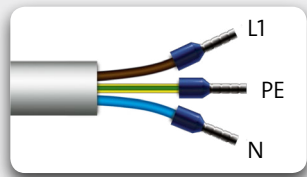

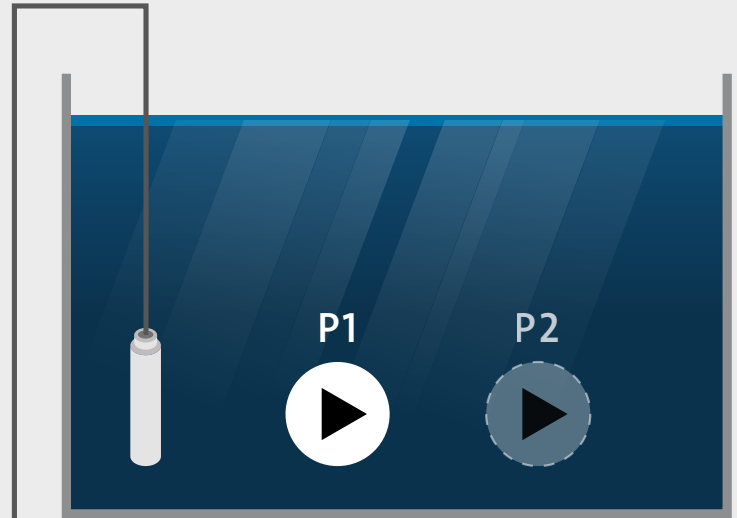
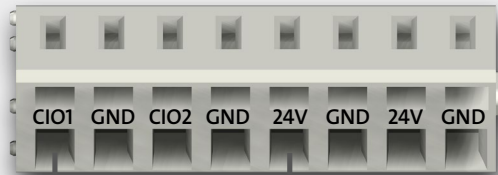
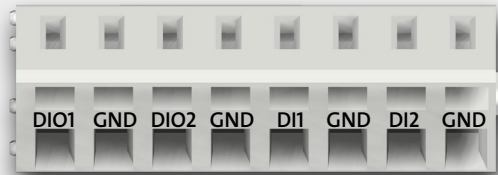

S-1 = analog

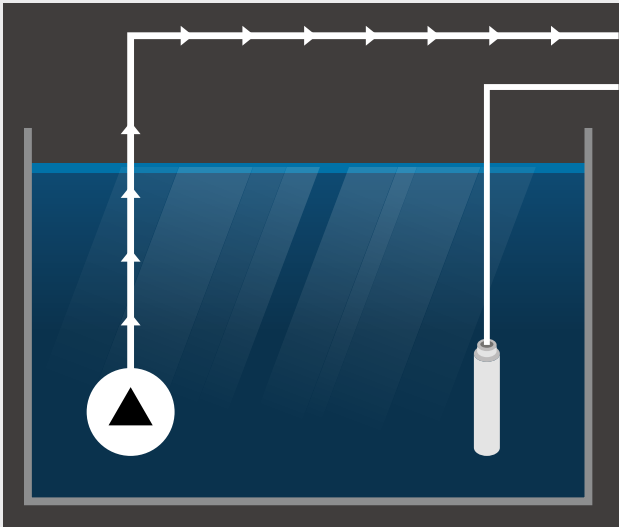



OK → ↑ ↓ → OK x 2

LC 231

On Off Auto On Off Auto

1 2

GRUNDFOS



↑ ↓ → OK x 2

LC 231

On Off Auto On Off Auto

1 2

GRUNDFOS

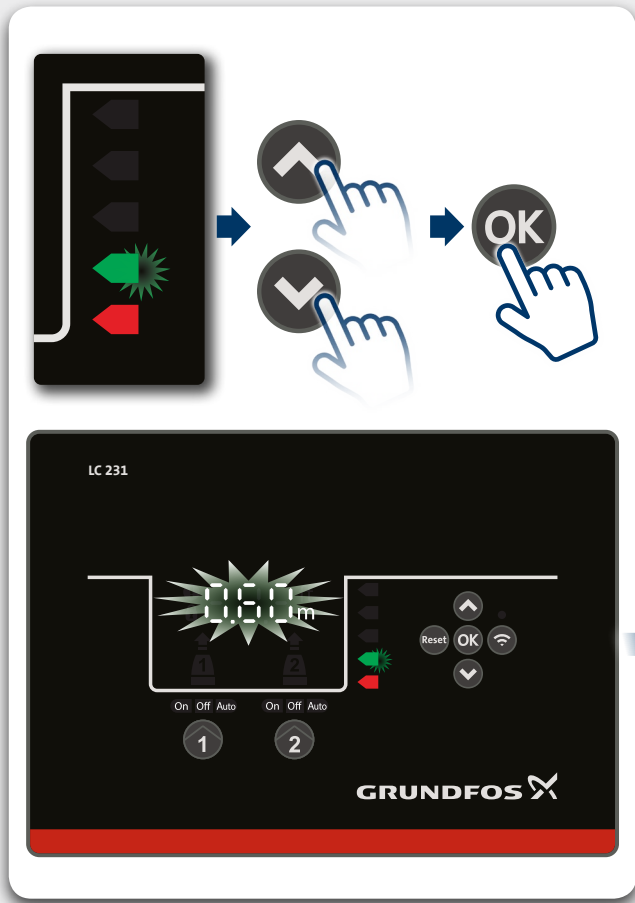
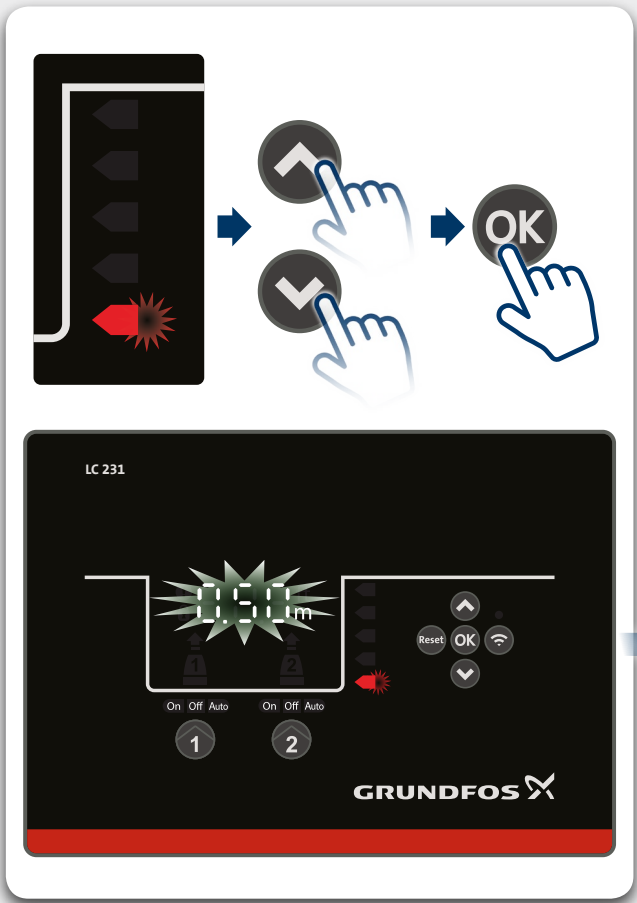



LC 231

On Off Auto On Off Auto

1 2

GRUNDFOS



LC 231

On Off Auto On Off Auto

1 2

GRUNDFOS

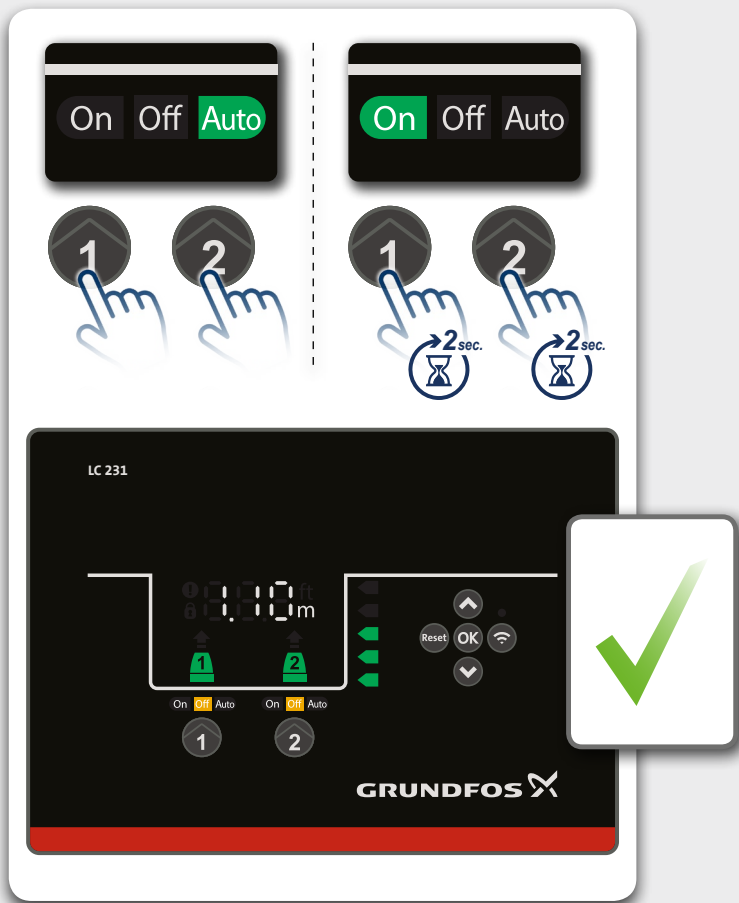
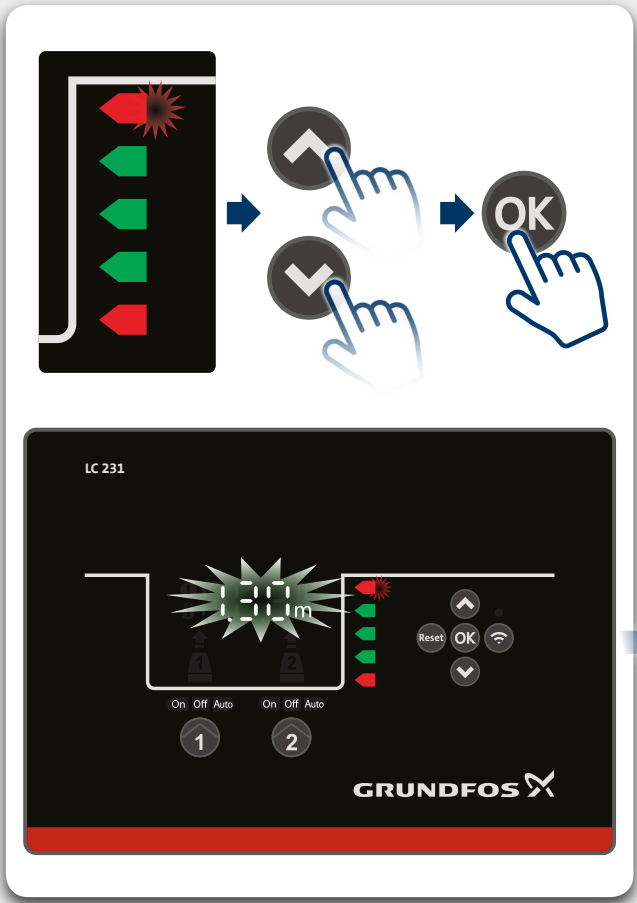

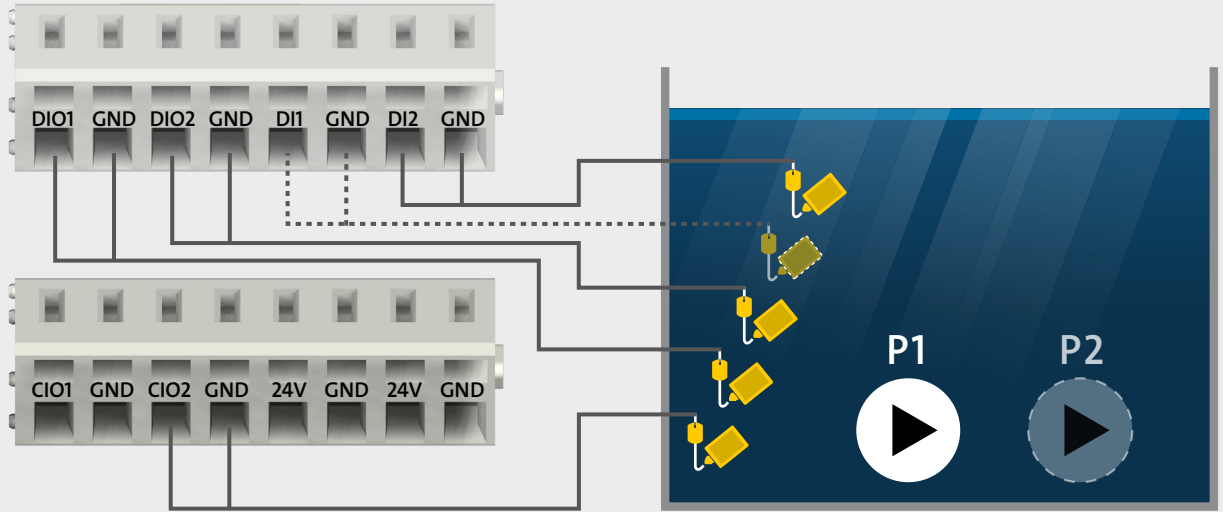

S-2 = digital

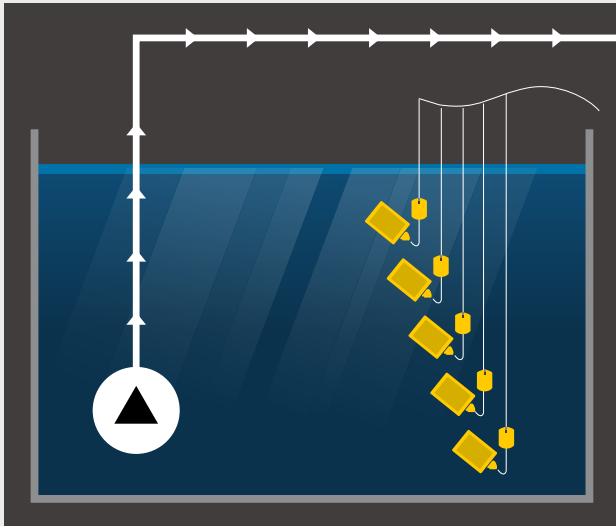

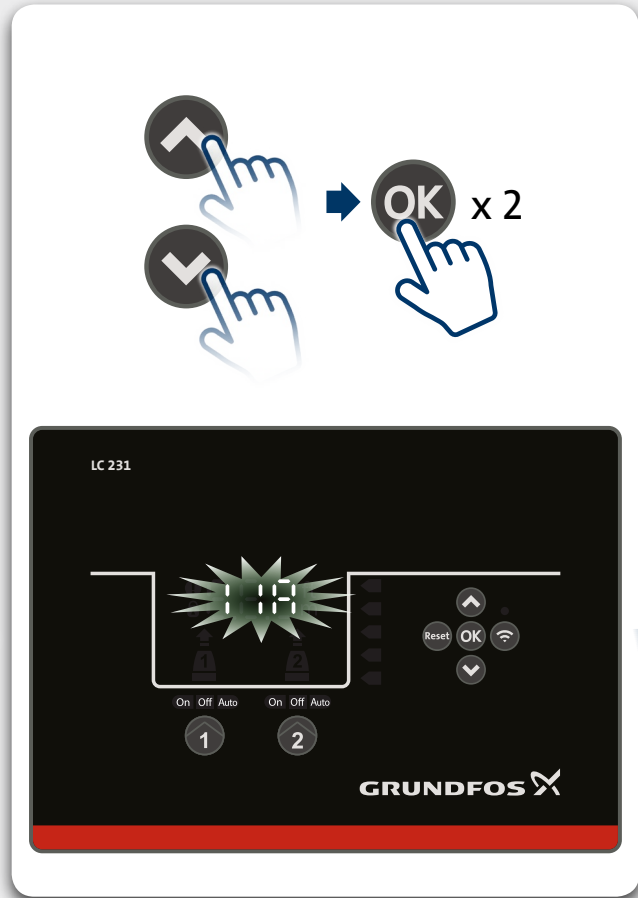
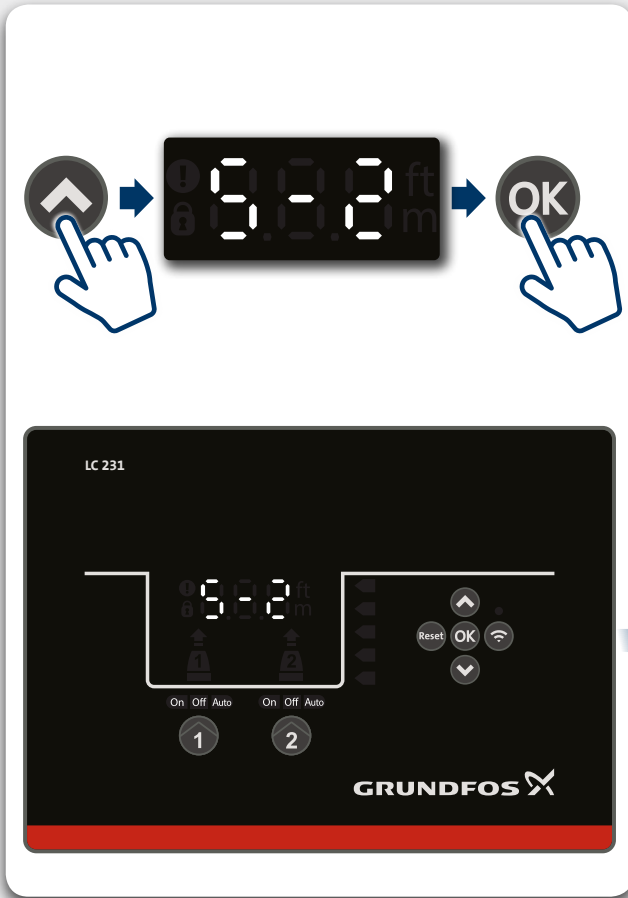

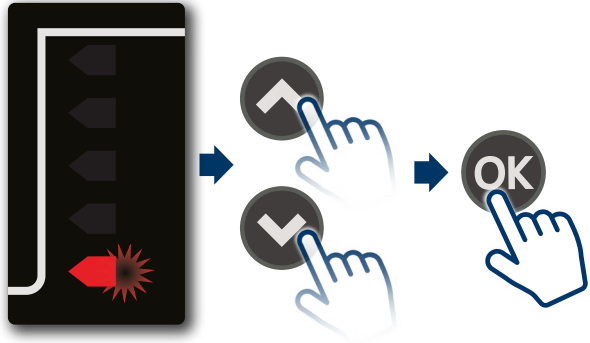
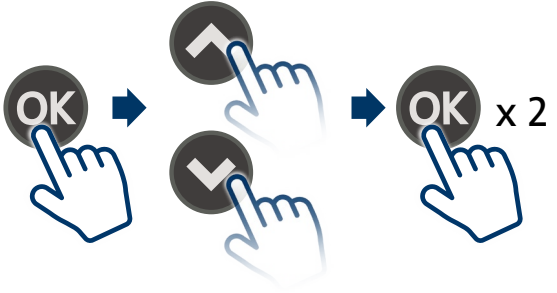



1 2

OK

LC 231

On Off Auto On Off Auto

1 2

GRUNDFOS

LC 231

On Off Auto On Off Auto

1 2

GRUNDFOS

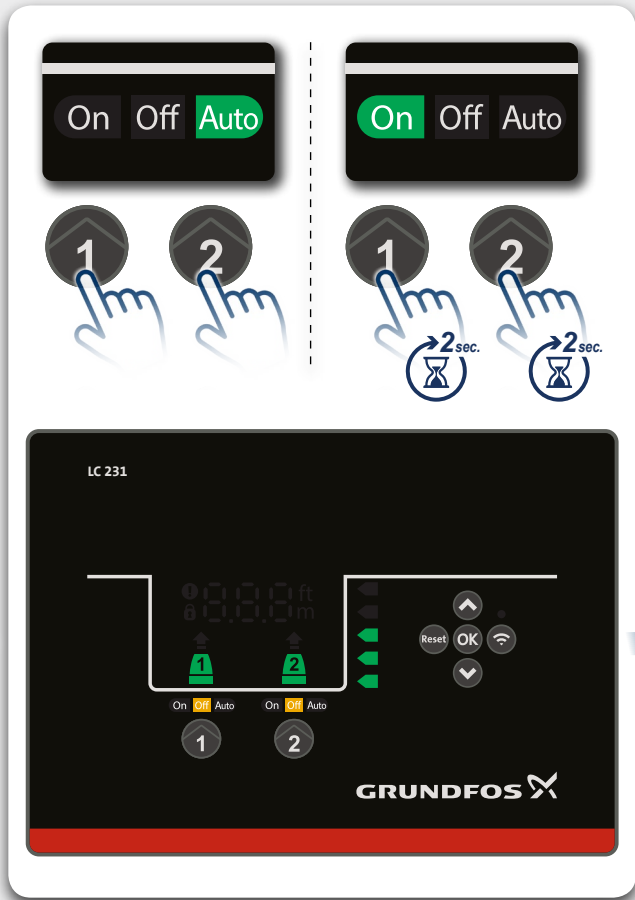

be think innovate

Installation date: _____

Installer:

99490947 0619

ECM: 1263637

GRUNDFOS Holding A/S
Poul Due Jensens Vej 7
DK-8850 Bjerringbro
Tel: +45 87 50 14 00
www.grundfos.com

GRUNDFOS 

Trademarks displayed in this material, including but not limited to Grundfos, the Grundfos logo and "be think innovate", are registered trademarks owned by The Grundfos Group. All rights reserved.
© 2019 Grundfos Holding A/S, all rights reserved.